

**VRP-SB-CH Pilot provides ZERO steady state bleed pressure control when used with single-acting actuators**

**Description:**

The Becker Model VRP-SB-CH Single-Acting Pilot provides pressure control when utilized with a single-acting actuated control valve. The VRP-SB-CH measures process sensing pressure and positions the single-acting actuator to maintain the pressure setpoint. The VRP-SB-CH Pilot may be utilized for pressure control applications with setpoints ranging from 1.0 psig to 1300 psig (6.9 kPa – 8964 kPa). The VRP-SB-CH features zero steady state bleed and may incorporate Becker's unique BPS™ Bleed to Pressure System capability to completely eliminate atmospheric emissions.

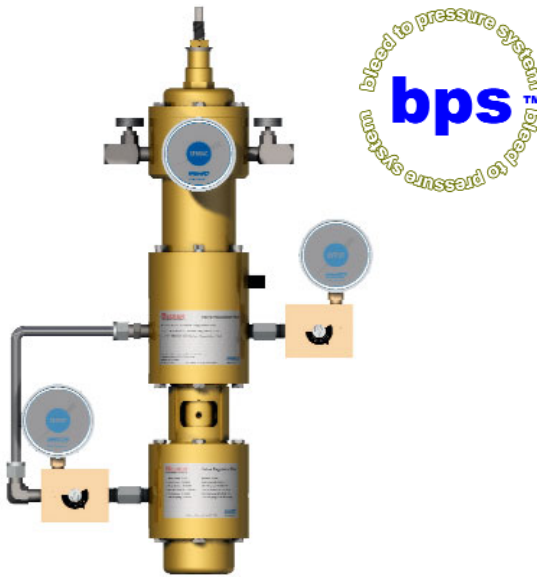

**Figure 1.0 - Becker Model VRP-600-SB-CH pressure control system. Reverse Acting configuration shown.**

VRP-SB-CH Applications	
•	Pressure Control
	Flow Control
	Power Plant Type Pressure Control
	Power Plant Type Flow Control
	Surge Control
Compatible Actuators	
	RPDA Series (Small Volume Models)
	RPDA Series (Large Volume Models)
•	RPSR Series
	LPDA Series (Small Volume Models)
	LPDA Series (Large Volume Models)
•	LPSR Series
•	LD Series

**Guidelines for Usage (Restrictions):**

**High Gain Systems:**

*Power plant feeds and other similar systems require fast stroking speed in order to satisfy required "gain" of the system. Becker VRP-SB-CH Series Pilots are NOT recommended for use in high gain applications that require fast stroking. For power Plant Type Applications, with LD Series Actuators, reference Becker's VRP-SB-PID Series Pilots.*

**Two-Stage Pressure Cuts:**

*Becker VRP-SB Series Pilots are not recommended for use as first stage pressure cut where two-stage (series) pressure cuts are incorporated. This includes "working monitor" regulators. For two-stage cut and working monitor applications, reference Becker's VRP-SB-PID Series Pilots.*

**CVE Globe Pattern Control Valves:**

*The Model VRP-SB-CH is compatible with LPSR Series Actuators when utilized with globe pattern control valves such as the Becker Globe Control Valve.*

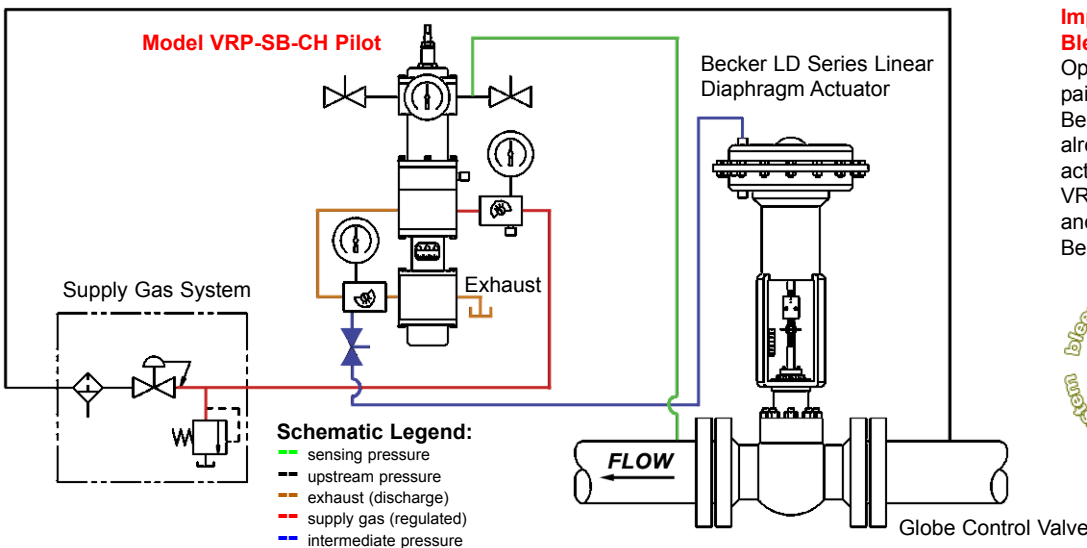

**Figure 2.0 — VRP-SB-CH Series Pilot configured for downstream pressure control**

The VRP-SB-CH may be utilized with any Becker single-acting series actuator and control valve combination to achieve downstream pressure control. Shown here with Becker Globe Control Valve and LD Series linear diaphragm actuator.

**Improve Performance and Minimize Bleed Gas Emissions!**

Optimum performance is achieved by pairing the VRP-SB-CH with genuine Becker control valve actuators. If you already have existing control valve actuators in service, the addition of a VRP-SB-CH can improve performance and minimize bleed gas emissions.

Becker VRP-SB-CH Pilots are compatible for retrofit with most manufacturer's single-acting actuators. Consult Becker Precision Equipment for more information.



**Benefits of the New VRP-SB-CH Combined Chamber Design:**

- The VRP-SB-CH Sensing Pressure and the Control Spring are combined in the same "CH" combined chamber so that only the "net force" is transmitted to the VRP-SB-CH Pilot Body Internals.
- VRP-SB-CH Pilot Sensitivity improved to  $\pm 0.75\%$ .
- The VRP-SB-CH control spring is totally enclosed and protected from potentially corrosive effects of the atmosphere.
- The New VRP-SB-CH design provides for substantially reduced number of models available. This makes selection and support of VRP-SB-CH Pilots easier.
- The New "CH" combined chamber is identical in design for all Becker VRP Pilots. Additionally, new control spring designs provide for wider setpoint range and greater sensitivity.
- The increased volume of the VRP-SB-CH combined chamber dampens any noise or vibration present in the measured variable (sensing tap).

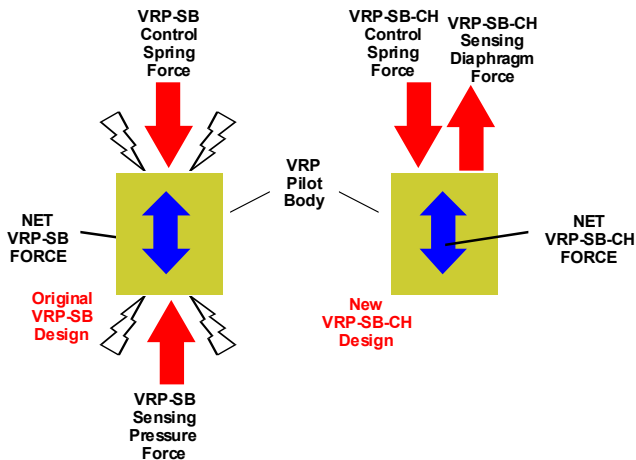

**Figure 3.1 – The Original VRP-SB Design Subjects the VRP-SB Pilot Body Internals to Crushing Forces**  
The VRP-SB Pilot is "sandwiched" between the VRP-SB Sensing Pressure Force and the VRP-SB Control Spring Force. The Net Force results tends to "crush" the VRP-SB Pilot Body Internals and reduce sensitivity and accuracy.  
**Original VRP-SB Accuracy =  $\pm 1.0\%$**

**Figure 3.2 – The New VRP-SB-CH Design Improves Setpoint Accuracy and Sensitivity**  
The new VRP-SB-CH Design combines the VRP-SB-CH Sensing Pressure Force and the VRP-SB-CH Control Spring Force within the "CH" Combined Chamber. The new "CH" design eliminates the crushing effect of internal forces and applies only the Net Force to the Pilot Body Internals. The result is increased setpoint accuracy and sensitivity.  
**New VRP-SB-CH Accuracy =  $\pm 0.75\%$**

**The new "combination chamber" of the Model VRP-B-CH Double-Acting Pilot provides improved performance over previous VRP-SB Pilot designs**

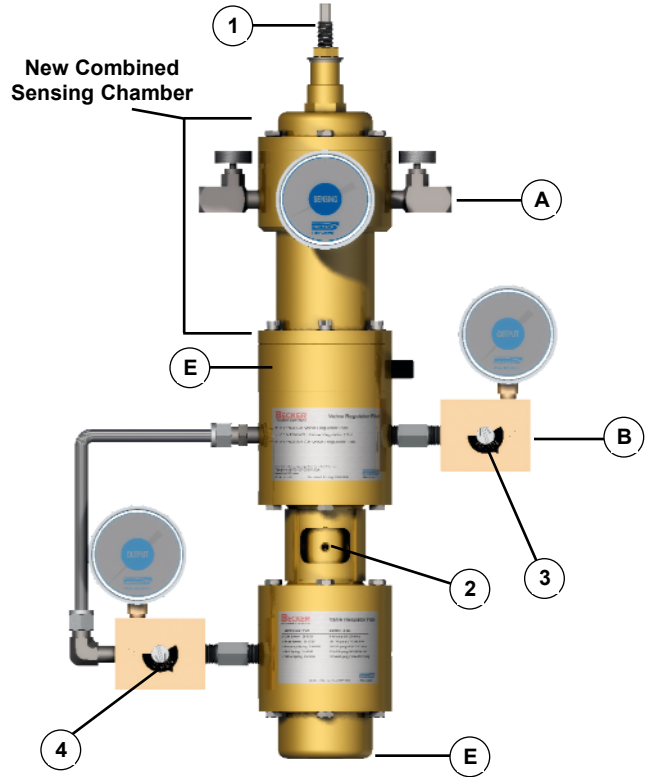

VRP-SB-CH Port Definitions	Port Size	Item
<b>Sensing (Input)</b>	1/4" FNPT	A
<b>Power Gas Supply (Input)</b>	1/4" FNPT	B
<b>Loading (Output)</b>	1/4" FNPT	C
<b>Exhaust (Discharge)</b>	1/4" FNPT	D
<b>Breather Vents</b>	1/4" FNPT	E
VRP-SB-CH Adjustments		Item
<b>Setpoint Adjustment</b>		1
<b>Deadband (Sensitivity)</b>		2
<b>"Loading" Adjustable Orifice</b>		3
<b>"Exhaust" Adjustable Orifice</b>		4

**Figure 4.0 – Becker Model VRP-600-SB-CH pressure control system**  
The VRP-SB-CH is specifically designed for use in natural gas pressure regulation and provides a simple, economical alternative to the controller/positioner combination.



**Improve Performance and Minimize Bleed Gas Emissions!**

Optimum performance is achieved by pairing the VRP-SB-CH with genuine Becker control valve actuators. If you already have existing control valve actuators in service, the addition of a VRP-SB-CH can improve performance and minimize bleed gas emissions. Becker VRP-SB-CH Pilots are compatible for retrofit with most manufacturer's single-acting style actuators. Consult Becker Precision Equipment for more information.

# VRP-SB-CH Series Valve Regulator Pilot

## How it Works:

### (Downstream Pressure Control)

VRP-SB-CH Configuration shown is reverse acting - VRP-SB-CH output decreases on rising sensing pressure. The LPSR Series Actuator is configured to fail closed on loss of pressure. The energy to operate the control valve is obtained from the differential between supply gas pressure and discharge gas pressure. When the measured variable (sensing) is at setpoint the pilot output remains in steady state with zero bleed. From a steady state position (figure 5.a), an increase in the sensing pressure causes the internal pistons to move down and vent pressure to the actuator (figure 5.b), closing the valve. The measured variable (sensing) returns to setpoint, and the pilot pistons center in the steady state position (figure 5.a) holding the control valve steady. If the measured variable falls below setpoint, the opposite reaction takes place (figure 5.c). Note that loss of supply gas causes the control valve to fail in the full closed position in the configuration shown.

### Schematic Legend:

- Atmospheric Pressure
- High Pressure Gas
- Cylinder Loading Pressure (High Pressure)
- Cylinder Loading Pressure (Medium Pressure)
- Cylinder Loading Pressure (Low Pressure)
- Measured Variable (Downstream Pressure)

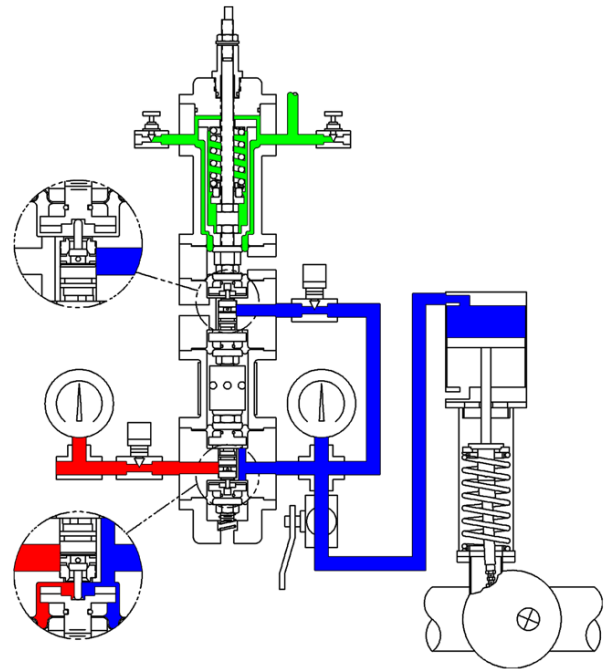

**Figure 5.1 – Setpoint satisfied**

When the measured variable is at setpoint the pilot output pressure remains static (Medium Loading) and holds the control valve stationary. Bleed gas is ZERO at steady state.

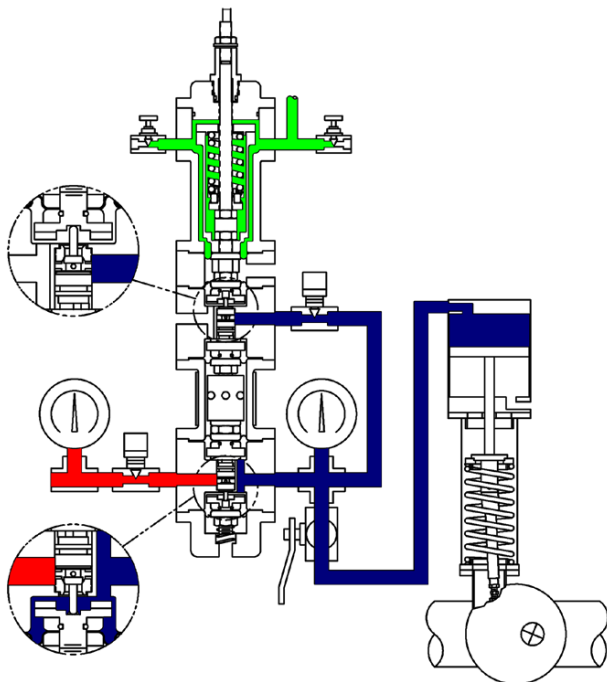

**Figure 5.2 – Downstream pressure climbs above setpoint**

When the measured variable rises above setpoint the pilot pistons move downward causing a decrease in cylinder loading pressure (light blue). The control valve moves toward the closed position. The VRP-SB-CH vents only enough pressure to reestablish the desired setpoint pressure.

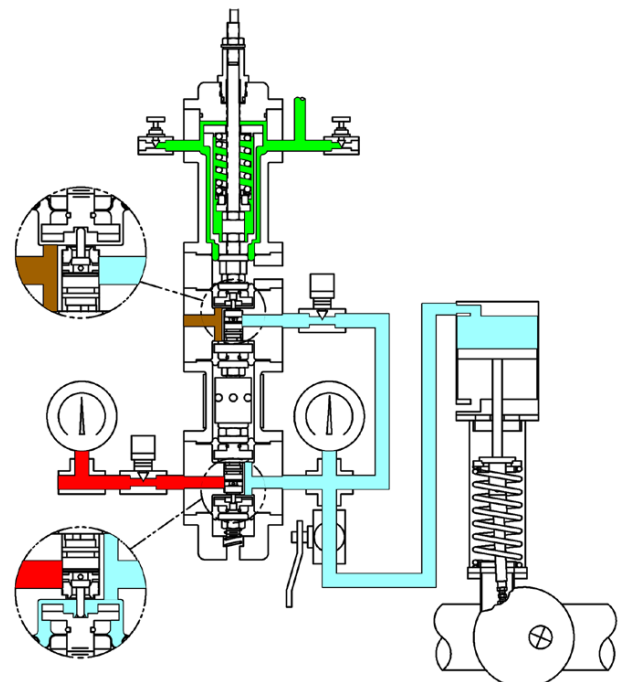

**Figure 5.3 – Downstream pressure falls below setpoint**

When the measured variable falls below setpoint the pilot pistons move upward causing an increase in cylinder loading pressure (dark blue). The control valve moves toward the open position. The VRP-SB-CH is non-bleeding in the "loading" mode.

Table 1.0 – Specifications for Model VRP-SB-CH Pilot

Technical Specifications	
Steady State Gas	ZERO (see Table 2.0)
Supply Gas	dry, filtered (100 micron) gas
Maximum flow capacity	2400 scfh (40 scfm)
Maximum Supply Pressure	400 psig (2758 kPa)
Maximum Supply-Discharge Differential	150 psig (1034 kPa)
Minimum Supply-Discharge Differential	20 psig (138 kPa)
Operative Ambient Temperature Range:	-20°F to 160°F (-29°C to 71°C)
Approximate Weight:	12 pounds (5.4 kg)
Minimum Deadband	0.2% instrument signal
Independent Linearity	±1.0% positioning range
Resolution	0.1% of positioning range
Control Accuracy	± 0.75% of setpoint
Maximum Sensing Pressure	1300 psig
Setpoint Range	1.0 psig – 1300 psig 6.9 kPa – 8966 kPa
Housing	meets NEMA 3 Classification
Installation Orientation	Vertical position recommended Custom bracket supplied with Becker Actuators 2" pipe mount provided for retrofit to other manufacturer's actuators
Materials of Construction	
External Parts	anodized AL 2024 316 SS available (for marine environments)
Internal Parts	316 SS and anodized AL 2024
Springs	alloy steel
Diaphragms	buna-n reinforced by nylon fabric
Seats and O-rings	buna-n
Tubing & Tubing Fittings	316 SS
Gauges	2½ inch dial liquid filled brass connection w/ stainless steel case* (standard issue with units of psig-dual units of psig/kPa available)
Notes: (1) Direct Acting: increasing input signal (sensing pressure) causes increasing output signal (2) Reverse Acting: decreasing input signal (sensing pressure) causes increasing output signal.	

	VRP-CH Pilot	VRP-B-CH Pilot	VRP-SB-CH Pilot	VRP-SB-PID Pilot	HPP-4 Positioner	HPP-5 Positioner	HPP-SB Positioner	EFP Positioner
Bleed Rates (Consumption)								
Steady State Bleed* Non-Bleed	~100	<10	zero	zero	~100	<10	zero	zero
Full-Open/Full Closed Bleed to Pressure	Y <sub>1</sub>	Y <sub>2</sub>	Y	Y	Y <sub>1</sub>	Y <sub>2</sub>	Y	Y
System (BPS™)†	Y	Y	Y	Y	Y	Y	Y	Y
Notes: *- Bleed rates are estimated utilizing Supply Gas Pressure=100 psig 1- Requires Model PS-2 or NBV Non-Bleed Device to eliminate bleed 2- Requires Model DPS-2 or NBV Non-Bleed Device to eliminate bleed †- Bleed to Pressure System (BPS™) eliminates all atmospheric bleed								

Table 2.0 – Bleed Rates (consumption) for Becker Control Instrumentation

Becker control instrumentation features low bleed and zero bleed technologies to minimize fugitive natural gas emissions and environmental impact.

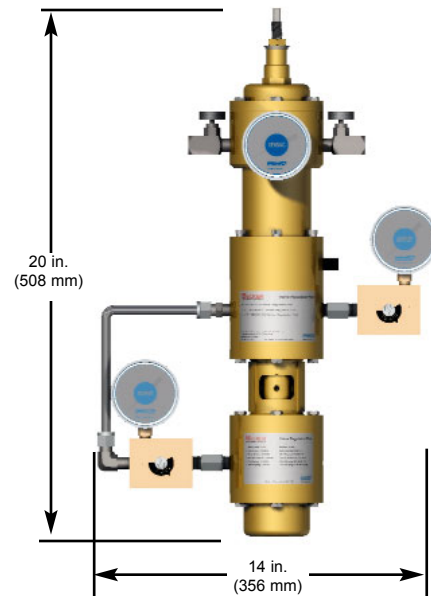

Figure 6.0 - Overall dimensions of Becker Model VRP-600-SB-CH Pilot Control System (Reverse Acting)

# VRP-SB-CH Series Valve Regulator Pilot

Table 3.0 - Selection Chart for VRP-SB-CH Series Pilots

VRP-SB-CH Model Number	Control Range (psig/kPa)	Spring Color	Part Number	Setpoint change/revolution of setpoint	Maximum Remote Setpoint Range <sup>3</sup>	Repair Kit Part Number
VRP-175-SB-CH <sup>1</sup>	3 – 10 psig 21 – 69 kPa	Gold	25-8236	0.57 psig/rev 3.9 kPa/rev	3.1 psig 21.4 kPa	30-9302
	7 – 30 psig 48 – 207 kPa	Beige	25-8238	2.0 psig/rev 14 kPa/rev	11 psig 75.8 kPa	30-9302
	15 – 50 psig 103 – 345 kPa	Burgundy	25-8239	3.0 psig/rev 21 kPa/rev	16.5 psig 113.8 kPa	30-9302
	20 – 85 psig 138 – 596 kPa	Pink	25-8240	6.4 psig/rev 44 kPa/rev	35.2 psig 242.7 kPa	30-9302
	50 – 175 psig 345 – 1207 kPa	Yellow	25-1306	23 psig/rev 159 kPa/rev	125 psig 862 kPa	30-9302
VRP-600-SB-CH	50 – 175 psig 345 – 1207 kPa	Burgundy	25-8239	11 psig/rev 76 kPa/rev	62 psig 427 kPa	30-9304
	135 – 300 psig 931 – 2069 kPa	Pink	25-8240	24 psig/rev 166 kPa/rev	132 psig 910 kPa	30-9304
	275 – 600 psig 1896 – 4137 kPa	Yellow	25-1306	85 psig/rev 590 kPa/rev	325 psig 2241 kPa	30-9304
VRP-1000-SB-CH	550 – 1000 3792 – 6895 kPa	Yellow	25-1306	144 psig/rev 990 kPa/rev	700 psig 4827 kPa	30-9305
VRP-1300-SB-CH	800 – 1300 psig 5516 – 8964 kPa	Gray	25-1562	227 psig/rev 1570 kPa/rev	900 psig 6206 kPa	30-9305

Notes:

- (1) These models should only be used for applications that require high gain. Consult Becker prior to specifying these models.
- (2) Maximum Remote Setpoint Range is based upon Model SM-1140 Remote Setpoint Module with maximum motor range of 5.8 revolutions. See Becker brochure RSM for additional information.
- (3) Maximum Remote Setpoint Range reported is applicable to units with discrete (pulse) signal. Remote Setpoint Modules with analog (4-20 mA) signal have a Maximum Remote Setpoint Range equal to the full Control Range of the VRP-SB-CH Pilot.

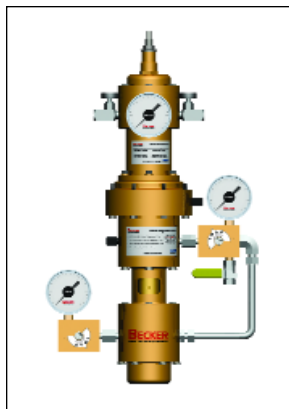

Figure 7.1  
Model VRP-175-SB-CH  
(Reverse Acting)



Figure 7.2  
Model VRP-600-SB-CH  
(Reverse Acting)



Figure 7.3  
Model VRP-1000-SB-CH  
(Reverse Acting)



Figure 7.4  
Model VRP-1300-SB-CH  
(Reverse Acting)

**VRP-SB-CH Series Pilot Accessories**

**Realize Optimum Performance of your VRP-SB-CH Series Pilot with these popular instrumentation accessories!**



**Engineered for the Environment**

**Bleed to Pressure System**

All Becker control instrumentation feature the unique capability to discharge vent gas into the downstream pipeline or alternate low pressure gas system. This feature is exclusive to Becker and provides complete elimination of atmospheric bleed gas emissions.



**AB Series Atmospheric Bleed Control:**

When conditions allow discharge to pressure system only part of the time, install an AB-Control for automatic switching that temporarily permits atmospheric bleed. The AB-Control will maintain adequate differential pressure between supply gas pressure and discharge pressure to operate the control valve actuator and the VRP-SB-CH. The AB-Control is not applicable when the VRP-SB-CH discharges to atmosphere all of the time.



**SP Series Setpoint Pump:**

Provides a simple and accurate method of applying false signal pressure during initial adjustment of the VRP-SB-CH pilot. The pump can provide a false signal pressure of 20%-50% in excess of working pipeline pressure which eliminates the need for nitrogen bottles or electronic calibration devices. The SP Series Setpoint Pump is compatible with all models and series of Becker VRP-SB-CH Pilots.



**RSM Series Remote Setpoint Module:**

The Remote Set Point Module provides remote adjustment of VRP-SB-CH Pilot set point via an electrical input signal. All Remote Setpoint Motors are equipped with internal limit switches to prevent over-travel of setpoint. 4-20 mA feedback of Remote Setpoint Module motor standard. All Becker RSM Series Remote Setpoint Modules are rated Explosion Proof Class 1, Div. 1 for use in hazardous locations. Standard RSM input signals are:

*Digital Pulse Input*

- 24 VDC
- 120 VAC

*Analog Current Input*

- 4-20 mA command signal/24 VDC Supply Power
- 4-20 mA command signal/120 VAC Supply Power



**VB Series Volume Boosters**

VB Series Volume Boosters are utilized in conjunction with Becker control instrumentation to provide adequate instrumentation flow volume for larger volume piston actuators. Volume Boosters are typically only required for Ball Valve Regulators model 12T and larger. Additionally, Volume Boosters may be utilized to provide increased actuator stroking speed when applications require, such as power plant and other short system applications. As with all Becker instrumentation, Volume Boosters may be discharged into a lower pressure system to eliminate atmospheric bleed. Volume Boosters are compatible with the VRP-SB-CH Valve Regulator Pilot.

# VRP-SB-CH Series Valve Regulator Pilot

## VRP-B-CH Series Pilot Accessories

Realize Optimum Performance of your VRP-B-CH Series Pilot with these popular instrumentation accessories!

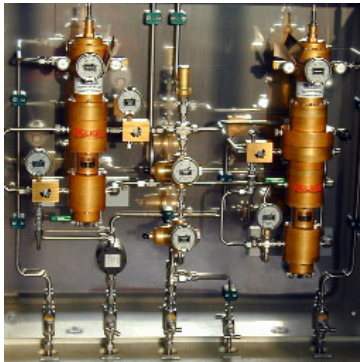

### Panel Mounting

Custom panel mounting is available to suit the specific needs of your application. All panels come fully assembled, tested and adjusted per your requirements. Panel mounting simplifies retrofit of Becker instrumentation to existing equipment and ensures satisfactory performance and fit. A variety of configurations and options are available.



### Stainless Steel Option

All Becker Precision Control instrumentation is manufactured from high-strength anodized aircraft aluminum alloy (AL2024). The standard aluminum construction typically will provide adequate durability in most installation environments. In applications where the installation environment is unusually harsh, the instrumentation may be specially ordered in a stainless steel option. The stainless steel option is typically utilized in the following areas:

- Marine environments
- Offshore platforms
- Chemical plants
- Coastal regions



**Figure 8.0 - VRP-SB-CH Retrofit Simplifies Control Instrumentation**

VRP-175-SB-CH pilot retrofit to a Fisher 657 direct acting spring & diaphragm actuator replacing a high bleed positioner and pressure controller combination. This retrofit replaced two control instruments with one instrument providing more reliable, accurate control with lower operational costs.

### Retrofit Compatibility:

Optimum performance is achieved by pairing the VRP-SB-CH with genuine Becker control valve actuators. If you already have existing control valve actuators in service, the addition of a Model VRP-SB-CH can improve performance and minimize atmospheric bleed emissions. Becker VRP-SB-CH Pilots are compatible for retrofit with most manufacturer's single-acting type actuators. Consult Becker Precision Equipment for assistance.

- Fisher Type 1051/1052™ (Rotary) and Type 657/667™ (Linear) spring & diaphragm type actuators\*
- Welker Jet® Control Valves\*
- Compatible with other manufacturer's system, consult Becker for assistance\*

*\*Consult Becker for additional information*



**Figure 9.0 - VRP-SB-CH Retrofit Virtually Eliminates Atmospheric Bleed Gas**

VRP-600-SB-CH pilot retrofit to a Fisher 657 direct acting spring & diaphragm actuator replacing an existing high bleed pressure controller. The installation will pay for itself in a short period of time based on elimination of steady state bleed emissions.

	VRP-CH Pilot	VRP-B-CH Pilot	VRP-SB-CH	VRP-SB-PID Pilot	HPP-4 Positioner	HPP-5 Positioner	HPP-SB Positioner	EFP Positioner	Notes
<b>Applications</b>									
Pressure Control	•	•	•	•	•	•	•	•	1,2
Flow Control					•	•	•	•	2
Power Plant Type Pressure Control	•			•	•	•	•	•	3
Power Plant Type Flow Control					•	•	•	•	3
Surge Control					•		•		
<b>Compatible Actuators</b>									
RPDA Series (Small Models)	•	•			•	•		•	4
RPDA Series (Large Models)	•				•			•	5
SYDA Series (Small Models)	•	•			•			•	
SYDA Series (Large Models)	•				•			•	
RPSR Series			•	•				•	
LPDA Series (Small Models)	•	•			•	•			4
LPDA Series (Large Models)	•				•			•	5
LPSR Series			•	•				•	
LD Series			•	•				•	6
<b>Instrumentation Options</b>									
Bleed to Pressure System BPS™	•	•	•	•	•	•	•	•	7
AB Series Atmospheric Bleed Control	•	•	•	•	•	•	•	•	
NBV Series No-Bleed Valve	•	•			•	•			8
DPS-2 Series Non-Bleed Sensor		•				•			9
PS-2 Series Non-Bleed Sensor	•				•				9
SP Series Setpoint Pump	•	•	•	•					
RSM Series Remote Setpoint Module	•	•	•	•					
Panel Mounting	•	•	•	•				•	
Stainless Steel Option	•	•	•	•	•	•	•	•	
VB Series Volume Booster	•		•	•	•				10
QEV Series Quick Exhaust Valve					•	•	•		

1. Pressure Control applications include: pressure letdown, primary regulation, monitors, standby, overpressure protection. Underpressure protection and relief valves.
2. All Positioners require controller device to perform pressure control or flow control.
3. Power Plant Regulation includes all power plants and "fast-acting" short systems.
4. RPDA, SYDA & LPDA Small Models are defined as actuator sizes <2000 in<sup>3</sup> (32,774 cm<sup>3</sup>)
5. RPDA, SYDA & LPDA Large Models are defined as actuator sizes >2000 in<sup>3</sup> (32,774 cm<sup>3</sup>)
6. LD Series Actuators are limited to Becker CVE Series Globe Valves
7. BPS $\Delta$  is limited to discharge pressure systems below 300 psig (2068 kPa). Consult Becker for application assistance.
8. NBV No-Bleed Valves may only be utilized when Pdischarge<60 psig (414 kPa) and/or Psupply<150 psig (1034 kPa).
9. PS-2 & DPS-2 Non-Bleed Sensors must be utilized when PDischarge>60 psig (414 kPa) and/or PSupply>150 psig (1034 kPa).
10. VB Series Volume Boosters are necessary for Power Plant Regulation, Surge Control Applications, or when Large Model SYDA, RPDA & LPDA Series Actuators are utilized.

\*CAUTION: This information is intended as a guideline for application of Becker Precision Equipment products. Becker strongly recommends consulting Becker Engineering prior to application of any product.



Figure 10.0 – Becker model VRP-175-SB-CH single-acting pilots installed on Masoneilan globe valves with spring & diaphragm actuators (above) and spring & piston actuators (below). Installations are in South America.



Figure 11.0 – Becker Below Ground Monitor Valve Becker Model VRP-600-SB-CH pilot installed on a fail-closed Becker RPSR series actuator used as over-pressure protection. The Becker FPCV-T0 Control Valve is buried for noise attenuation.

**Toll-Free Assistance!**

**(800) 323-8844**  
USA & Canada

**DRESSER**  
Flow Solutions

**BECKER**  
PRECISION EQUIPMENT

Dresser Flow Solutions, Becker Operations  
1550 Greenleaf Avenue  
Elk Grove Village, Illinois 60007 USA  
Phone: 847-437-5940  
Fax: 847-437-2549  
Toll Free: 800-323-8844

E-mail: becker@dresser.com  
Website: www.bpe950.com